

# Grafoplast®

## Wire Markers

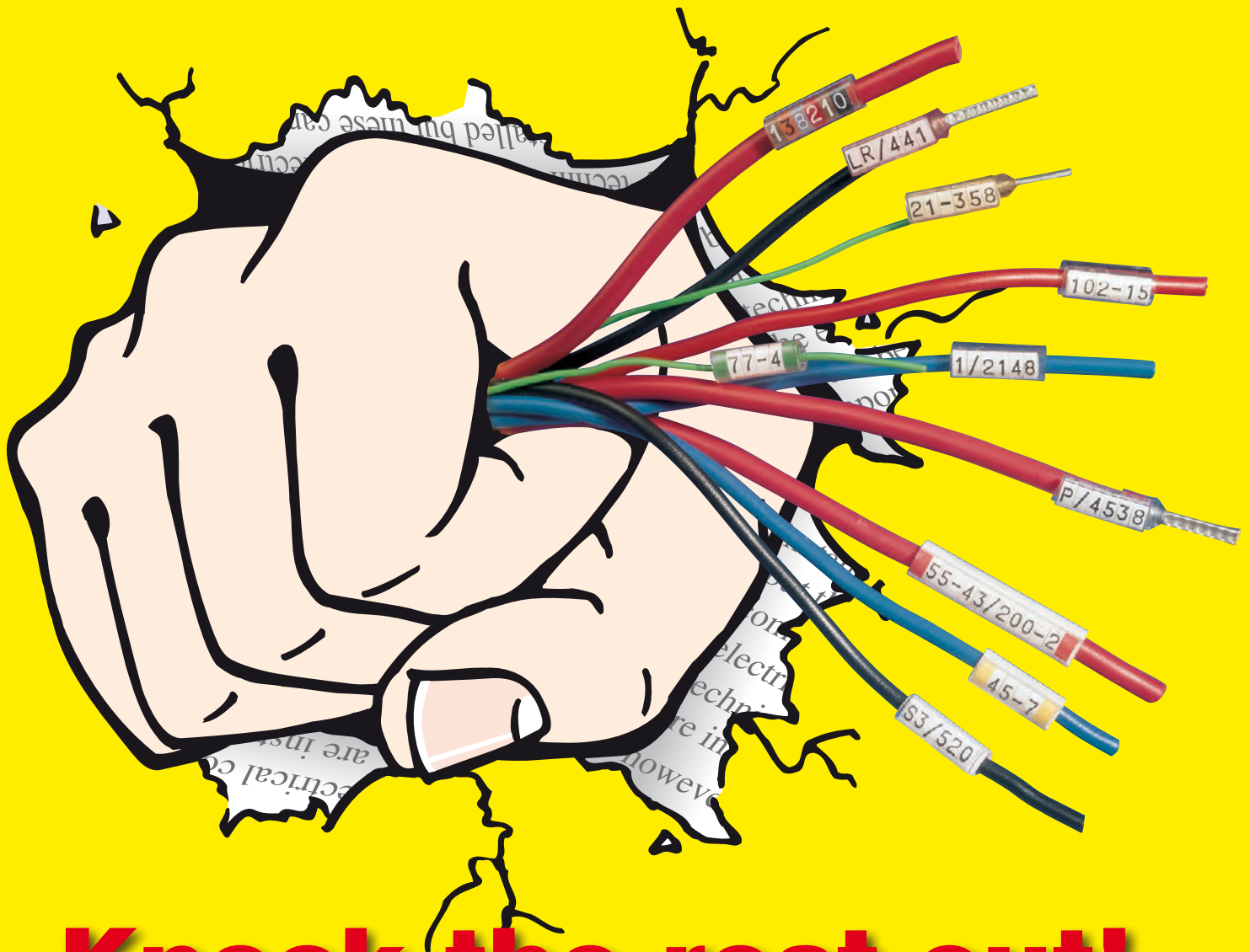

### Knock the rest out!

Phone: 1-303-321-5995  
Fax: 1-303-399-5054  
Toll Free: 1-800-864-3874  
[www.grafoplast.com](http://www.grafoplast.com)

**Catalog/Price List U.S.A**  
Effective September 1st 2008  
Prices subject to change



Starter Kit



Trasp Marking Elements

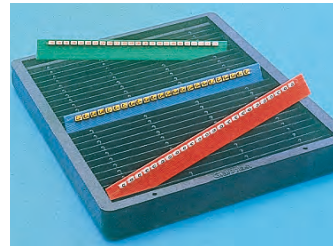

Strip Trays



Applicators & Removal Hook

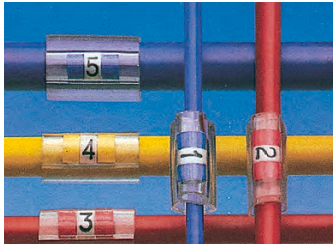

Slide-on Sleeves

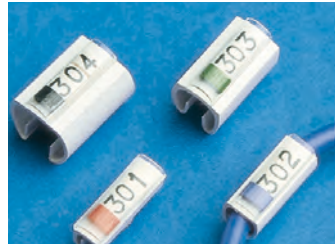

Snap-on Sleeves

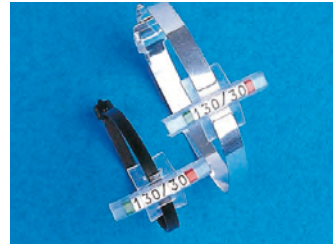

Sleeves for Cable Ties



Ring & Spade Terminals



Spark Crimp-on Pins



PLC Marking

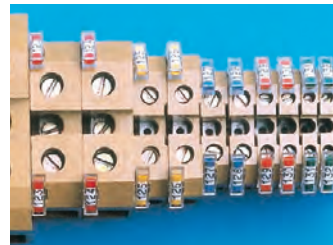

Terminal Blocks

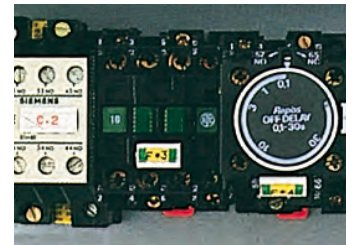

Contactors and Relays



Self Sticking Labels

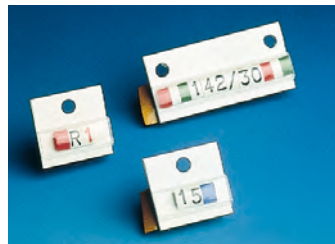

Self Sticking Labels



Self Sticking Channel and  
Clip-in Markers



Stainless Steel, Aluminium  
PVC Straps

 **Grafoplast®**

**Quick and easy to apply  
Lasts forever**

**The one system for every application**

**We deal direct, we deliver  
next day, we pay the freight!**

 **Grafoplast®  
Wiremakers Inc.**

6875 East 48th Avenue, Denver, CO 80216 USA

1-800-864-3874 OR FAX 1-800-864-3875

©Since 1993 Grafoplast Wiremakers Inc.



# INDEX

## TRASP MARKING SYSTEM

The ultimate manual wiremarking system for every size wire/cable.

INTRODUCTORY KITS	PAGE 04
ACCESSORY KITS	PAGE 05
MARKING ELEMENTS	PAGE 06
HOW TO USE (4 Easy Steps)	PAGE 07
PRICE LISTS	PAGE 08



## COMPUTER GENERATED WIRE MARKING

Three options that provide all your wiremarking needs.



## IN HOUSE MARKING SERVICE

We'll mark it for you. 72 hour turnaround. Free delivery.



## SI2K SYSTEM

The future is here with our SI2K thermal transfer printer.



## SI2000 PLOTTER SYSTEM

The best plotter for Halogen Free tags available.



## CABLE DIAMETER COMPARISON

A guide to how outside diameter compares to millimeters squared



## TERMINAL BLOCK DIAGRAM

Which marker for which block? All is revealed on page 23

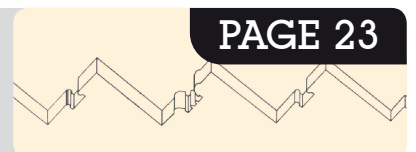

## 001SK STARTER KIT

The best choices for starting with the Grafoplast system.



\$ 786.00

### CONTENTS:

PART #	QTY	DESCRIPTION
118	2	Strip Tray
119/15	1	Marking Applicator Tool
119/30	1	Marking Applicator Tool
120	1	Removal Hook

### STRIPS INCLUDED:

24 characters per strip

PART #	QTY	PART #	QTY
117MAABW	10	117M00BW	10
117MBBBW	10	117M01BW	10
117MCCBW	10	117M02BW	10
117MDDBW	10	117M03BW	10
117MEEBW	10	117M04BW	10
117MFFBW	10	117M05BW	10
117MGGBW	10	117M06BW	10
117MHHBW	10	117M07BW	10
117MIIBW	10	117M08BW	10
117MJJBW	10	117M09BW	10
117MKKBW	10	117M10BW	10
117MLLBW	10	117M11BW	10
117MMMBW	10	117M12BW	10
117MNNBW	10	117M13BW	10
117MOOBW	10	117M999B	10
117MPPBW	10	117M999R	10
117MQQBW	10	117M999G	10
117MRRBW	10	117M999Y	10
117MSSBW	10	117M999U	10
117MTTBW	10		
117MUUBW	10		
117MVVBW	10		
117MWWBW	10		
117MXXBW	10		
117MYYBW	10		
117MZZBW	10		

### SLEEVES INCLUDED:

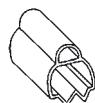

PART #	QTY
102/15	1000

## 050C TRASP CASE

"Field Friendly" - the best choice for field work.



\$ 351.00

### CONTENTS:

PART #	QTY	DESCRIPTION
118	2	Strip Tray
119M/15	1	Marking Applicator Tool with handle
119M/30	1	Marking Applicator Tool with handle
120	1	Removal Hook

### STRIPS INCLUDED:

24 characters per strip

PART #	QTY	PART #	QTY
117MAABW	2	117M00BW	4
117MBBBW	2	117M01BW	4
117MCCBW	2	117M02BW	4
117MDDBW	2	117M03BW	2
117MEEBW	2	117M04BW	2
117MFFBW	2	117M05BW	2
117MGGBW	2	117M06BW	2
117MHHBW	2	117M07BW	2
117MIIBW	2	117M08BW	2
117MJJBW	2	117M09BW	2
117MKKBW	2	117M10BW	2
117MLLBW	2	117M11BW	2
117MMMBW	2	117M12BW	2
117MNNBW	2	117M13BW	2
117MOOBW	2	117M14BW	2
117MPPBW	2	117M29BW	2
117MQQBW	2	117M33BW	1
117MRRBW	2	117M999B	2
117MSSBW	2	117M999G	2
117MTTBW	2	117M999O	1
117MUUBW	2	117M999R	2
117MVVBW	2	117M999U	2
117MWWBW	2	117M999W	2
117MXXBW	2	117M999Y	2
117MYYBW	2		
117MZZBW	2		

### SLEEVES INCLUDED:

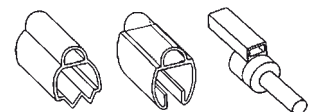

PART #	QTY	PART #	QTY	PART #	QTY
101/15	160	190/05	50	304/30	15
102/15	80	190/10	30	710/07	50
103/15	90	190/15	30	710/15	50
108/15	90	301/15	30	710/25	50
140/15	20	302/15	30		
140/30	20	303/30	15		

# INTRODUCTORY KITS

## 012C TRASP BOX

For the smaller user, primarily using numbers.



### CONTENTS:

PART #	QTY	DESCRIPTION
118	1	Strip Tray
119/15	1	Marking Applicator Tool
119/30	1	Marking Applicator Tool
120	1	Removal Hook

### STRIPS INCLUDED:

24 characters per strip

PART #	QTY		
117MAABW	1	117M06BW	1
117MBBBW	1	117M07BW	1
117MCCBW	1	117M08BW	1
117MDDBW	1	117M09BW	1
117M00BW	3	117M10BW	1
117M01BW	3	117M11BW	1
117M02BW	3	117M13BW	1
117M03BW	2		
117M04BW	2		
117M05BW	1		

### SLEEVES INCLUDED:

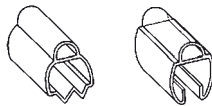

PART #	QTY		
101/15	70	104/30	30
101/30	25	301/15	10
102/15	70	302/15	10
102/30	30	303/30	5
103/15	60	304/30	5
103/30	30		
104/15	60		



# ACCESSORY KITS

## 012A TRASP BOX



### CONTENTS:

PART #	QTY	DESCRIPTION
118	1	Strip Tray
119/15	1	Marking Applicator Tool
119/30	1	Marking Applicator Tool
120	1	Removal Hook

## 013A TRASP BOX



### CONTENTS:

PART #	QTY	DESCRIPTION
118	2	Strip Tray
119/15	1	Marking Applicator Tool
119/30	1	Marking Applicator Tool
120	1	Removal Hook

## 050A TRASP CASE



### CONTENTS:

PART #	QTY	DESCRIPTION
118	2	Strip Tray
119/15	1	Marking Applicator Tool
119/30	1	Marking Applicator Tool
120	1	Removal Hook

## 005RK READY KIT WITH ACCESSORIES



### CONTENTS:

PART #	QTY	DESCRIPTION
	1	Case
	2	Inner Trays
006	50	Comb Shaped Sleeve Holders

## 006 REPLACEMENT COMBS



### CONTENTS:

PART #	QTY	DESCRIPTION
006	25	Comb Shaped Sleeve Holders

## ORDERING CODE

PART NUMBER	WIDTH	Nº OF CHARACTERS PER SLEEVE				COLOUR COMBINATIONS	
All marking element strips are part number 117	Large = G	<b>MARKING ELEMENT SIZE</b>	<b>SLEEVE LENGTH(mm)</b>				BW = Black print on white background BY = Black print on yellow background
	Medium = M		<b>10</b>	<b>15</b>	<b>23</b>	<b>30</b>	
	Small = P	117P Small 1.8mm	5	8	12	16	
		117M Medium 2.3mm	4	6	10	13	
		117G Large 3.0mm	3	5	7	10	

EXAMPLES

117	M	AA	BW	medium letters	A	black character on white	
117	M	01	BW	medium numbers	1	black character on white	
117	P	HH	BW	small letters	H	black character on white	
117	P	09	BW	small numbers	9	black character on white	
117	G	ZZ	BW	large letters	Z	black character on white	
117	G	05	BW	large numbers	5	black character on white	
117	M	KK	BY	medium letters	K	black character on yellow	
117	M	06	BY	medium numbers	6	black character on yellow	

### CHARACTER VARIATIONS

Your choice of alpha, numeric, symbol, colour as per the columns below

ALPHA	NUMERIC	SYMBOLS
A = AA	0 = 00	+ = 10
B = BB	1 = 01	- = 11
C = CC	2 = 02	⊥ = 12
D = DD	3 = 03	/ = 13
E = EE	4 = 04	· = 14
F = FF	5 = 05	▲ = 15
G = GG	6 = 06	λ = 16
H = HH	7 = 07	~ = 17
I = II	8 = 08	= = 18
J = JJ	9 = 09	Ω = 19
K = KK		* = 20
L = LL		( = 21
M = MM		) = 22
N = NN		, = 23
O = OO		ρ = 28
P = PP		∅ = 29
Q = QQ		‘ = 32
R = RR		: = 33
S = SS		÷ = 34
T = TT		→ = 35
U = UU		← = 36
V = VV		↑ = 37
W = WW		↓ = 38
X = XX		# = 39
Y = YY		& = 48
Z = ZZ		" = 49

### PLAIN COLOURS

Black = 999B	Red = 999R
Grey = 999E	Blue = 999U
Green = 999G	Violet = 999V
Brown = 999N	White = 999W
Orange = 999O	Yellow = 999Y
Pink = 999P	

### INTERNATIONAL COLOUR CODES

0 117M00WB	5 117M05WG
1 117M01WN	6 117M06WU
2 117M02WR	7 117M07WV
3 117M03BO	8 117M08WE
4 117M04BY	9 117M09BW



### STANDARD PACK 1200 ELEMENTS

Marking Elements 50 strips x 24 elements  
= 1200 pieces one character per pack.

**\$58.00**  
per pack



### BLISTER PACK 240 ELEMENTS

Marking Elements 10 strips x 24 elements = 240 pieces one character per pack. Minimum purchase 5 packs.

**NOTE:** Supplied in black characters on white background in numbers, letters, +, -, / and ⊥ symbols only.

#### EXAMPLE ORDER CODES:

BL 117MAABW = medium letters, character: A,  
black characters on white

BL 117M01BW = medium numbers, character: 1,  
black characters on white

\*Minimum order quantity 5 blister packs

**\$16.00**  
per pack

# 4 Easy Steps

For The **Ultimate** Wiremarking System

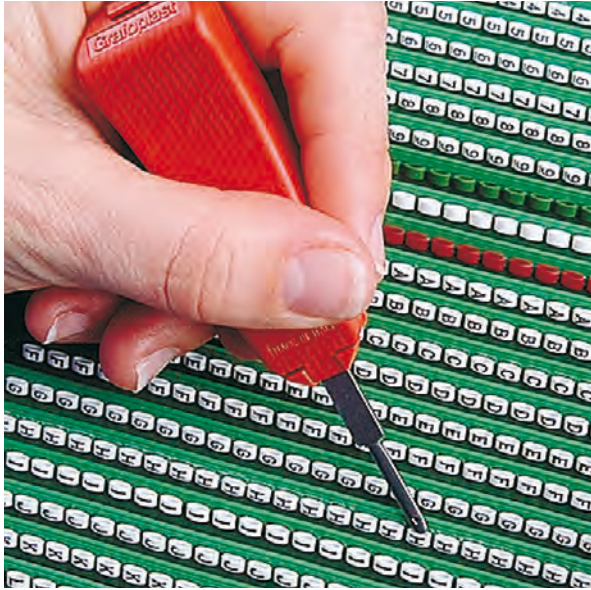

**Step 1** Collect the marking elements on the applicator



**Step 2** Insert elements into the sleeve

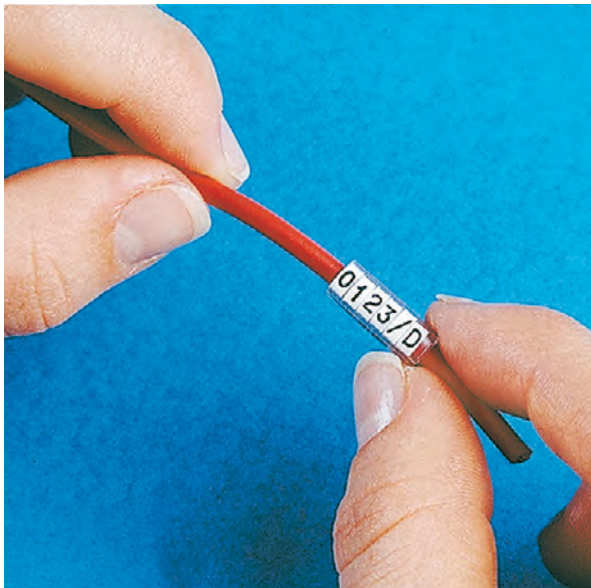

**Step 3** Slide sleeves on to wire

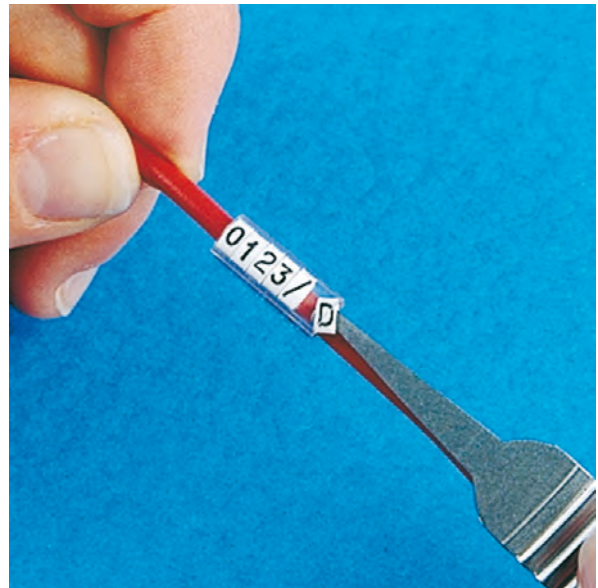

**Step 4** Marking elements can be added or removed as required with removal hook

Get up to 6 Characters on a wire in 10 seconds, and it's permanent.

**“The ultimate wire marker at an ordinary price.”**

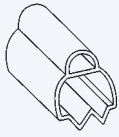

ITEM	CODE	DESCRIPTION	QTY	PRICE
<b>Transparent Sleeves</b>				
<b>100 Series</b>				
	101/10	10mm	1000 pieces	39.00
	101/15	15mm	1000 pieces	46.00
	101/18	18mm	1000 pieces	71.00
	101/23	23mm Cable O.D. 1-2mm (.039" - .078") 18-20 AWG	1000 pieces	71.00
	101/30	30mm	500 pieces	46.00
	101/40	40mm	500 pieces	52.00
	101/MT	25M Roll	1 piece	72.00
	102/10	10mm	1000 pieces	45.00
	102/15	15mm	1000 pieces	51.00
	102/18	18mm	1000 pieces	78.00
	102/23	23mm Cable O.D. 2-3mm (.078" - .11") 14-16 AWG	1000 pieces	78.00
	102/30	30mm	500 pieces	51.00
	102/40	40mm	500 pieces	57.00
	102/MT	25M Roll	1 piece	80.00
	103/10**	10mm	1000 pieces	45.00
	103/15**	15mm	1000 pieces	52.00
	103/18**	18mm	500 pieces	40.00
	103/23**	23mm Cable O.D. 3-4mm (.11" - .15") 10-12 AWG	500 pieces	40.00
	103/30**	30mm	500 pieces	51.00
	103/40**	40mm (for Cat5 wire)	200 pieces	24.00
	103/MT**	25M Roll	1 piece	80.00
	104/10	10mm	1000 pieces	56.00
	104/15	15mm	1000 pieces	62.00
	104/23	23mm Cable O.D. 4-5mm (.15" - .19") 5-6 AWG	500 pieces	46.00
	104/30	30mm	500 pieces	62.00
	104/MT	25M Roll	1 piece	95.00
	105/10	10mm	1000 pieces	51.00
	105/15	15mm	1000 pieces	62.00
	105/30	30mm Cable O.D. 5-6mm (.19" - .23") 3-4 AWG	500 pieces	62.00
	105/MT	25M Roll	1 piece	95.00
	106/10	10mm	500 pieces	30.00
	106/15	15mm	500 pieces	32.00
	106/23	23mm	200 pieces	24.00
	106/30	30mm Cable O.D. 6-7mm (.23" - .27") 2 AWG	200 pieces	26.00
	106/MT	25M Roll	1 piece	95.00
	107/10	10mm	500 pieces	30.00
	107/15	15mm	500 pieces	34.00
	107/30	30mm Cable O.D. 7-8mm (.27" - .31") 1 AWG	200 pieces	27.00
	107/MT	25M Roll	1 piece	102.00
	108/10	10mm	500 pieces	30.00
	108/15	15mm	500 pieces	34.00
	108/23	23mm	200 pieces	24.00
	108/30	30mm Cable O.D. 8-10mm (.31" - .39")	200 pieces	29.00
	108/MT	25M Roll	1 piece	102.00
	109/10	10mm	500 pieces	35.00
	109/15	15mm	500 pieces	46.00
	109/30	30mm Cable O.D. 10-12mm (.39" - .47")	200 pieces	36.00
	109/MT	500mm bars	40 bars	116.00
	110/10	10mm	500 pieces	45.00
	110/15	15mm	500 pieces	46.00
	110/30	30mm Cable O.D. 12-14mm (.47" - .55")	200 pieces	36.00
	110/MT	500mm bars	40 bars	116.00
	111/15	15mm	200 pieces	23.00
	111/30	30mm Cable O.D. 14-16mm (.55" - .62")	100 pieces	23.00
	111/MT	500mm bars	40 bars	140.00
	112/15	15mm	200 pieces	23.00
	112/30	30mm Cable O.D. 16-18mm (.62" - .70")	100 pieces	23.00
	112/MT	500mm bars	40 bars	140.00
	113/15	15mm	200 pieces	23.00
	113/30	30mm Cable O.D. 18-20mm (.70" - .78")	100 pieces	23.00
	113/MT	500mm bars	40 bars	140.00
	114/15	15mm	100 pieces	11.00
	114/30	30mm Cable O.D. 20-22mm (.78" - .86")	50 pieces	11.00
	114/MT	500mm bars	20 bars	70.00
	115/15	15mm	100 pieces	16.00
	115/30	30mm Cable O.D. 22-25mm (.86" - .98")	50 pieces	16.00
	115/MT	500mm bars	20 bars	84.00

\*Available upon request      \*\*suitable for Cat5 wire

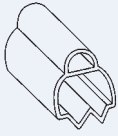
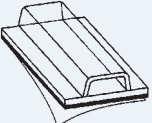

ITEM	CODE	DESCRIPTION	QTY	PRICE
<b>Transparent Sleeves</b> <b>100 Series</b> <b>Continued</b> 	116/15	15mm	50 pieces	9.00
	116/30	30mm	Cable O.D. 25-30mm (.98" - 1.18") 50 pieces	17.00
	116/MT	500mm bars	20 bars	84.00
	201/15	15mm	Cable O.D. 1.5-2.5mm 16-20 AWG 1000 pieces	45.00
	201/30	30mm	Cable O.D. 1.5-2.5mm 16-20 AWG 500 pieces	27.00
	202/15	15mm	Cable O.D. 2-4mm 10-14 AWG 1000 pieces	47.00
	203/15	15mm	Cable O.D. 4-7mm 2-6 AWG 500 pieces	30.00
	208/15	15mm	50 pieces	9.00
	208/30	30mm	Cable O.D. 30-35mm (1.18" - 1.37") 50 pieces	17.00
	208/MT	500mm bars	20 bars	78.00
	209/15	15mm	50 pieces	9.00
	209/30	30mm	Cable O.D. 35-40mm (1.37" - 1.57") 50 pieces	17.00
	209/MT	500mm bars	20 bars	80.00
<b>Strip Tray</b> 	118	Strip Tray Holds 25 Strips	1 piece	42.00
<b>Marking Tools</b> 	119/15	15mm	Marking Element Applicator 5 pieces	56.00
	119/30	30mm	Marking Element Applicator 5 pieces	74.00
<b>Marking Tools With Handle</b> 	119M/15	15mm	Marking Element Applicator with handle 1 piece	20.00
	119M/30	30mm	Marking Element Applicator with handle 1 piece	24.00
<b>Removal Hook</b> 	120	Marking Element Removal Hook	5 pieces	52.00
<b>Metal Straps</b> 	121/23	170mm	Aluminium with 23mm sleeve 200 pieces	88.00
	122/30	220mm	Aluminium with 30mm sleeve 100 pieces	62.00
	123*	400mm	Aluminium without sleeve 100 pieces	129.00
	121X/23	170mm	Stainless with 23mm sleeve 200 pieces	126.00
	121X*	170mm	Stainless without sleeve 200 pieces	101.00
	122X/15*	220mm	Stainless with 15mm sleeve 100 pieces	72.00
	122X/30	220mm	Stainless with 30mm sleeve 100 pieces	76.00
	122X*	220mm	Stainless without sleeve 100 pieces	59.00
<b>PVC Strap for Flat Ribbon Cable</b> 	124/15	205mm	PVC strap with 15mm sleeve 200 pieces	106.00
<b>Cable Tie Sleeve</b> 	130/23**	23mm	Use with up to 6mm wide cable ties 200 pieces	27.00
	130/30**	30mm	Use with up to 6mm wide cable ties 200 pieces	30.00
<b>Adhesive Labels</b> 	140/15**	15mm	Adhesive labels 500 pieces	65.00
	140/30**	30mm	Adhesive labels 200 pieces	52.00
	140/MT* **	500mm	Adhesive Bars 20 Bars	92.00
	S1 1002	20mm	Adhesive compatible SIHS44 240 pieces	34.00
<b>Adhesive Labels with Fixing Hole</b> 	142/15	15mm	Adhesive labels with 1 fixing hole 500 pieces	76.00
	142/30	30mm	Adhesive labels with 2 fixing holes 200 pieces	62.00

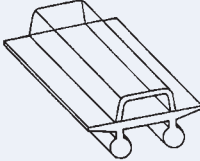
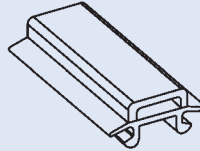
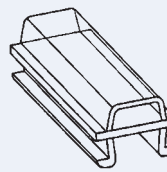
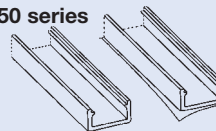
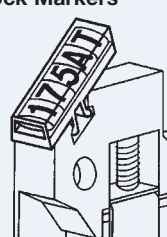
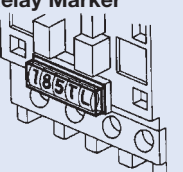
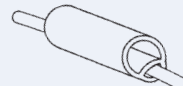
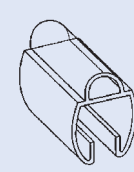

\*Available upon request

\*\*suitable for Cat5 wire

ITEM	CODE	DESCRIPTION	QTY	PRICE		
<b>Clip-in Label for Adhesive Channel</b> 	150/10*	10mm	Clip in label for item 161/MT	500 pieces	40.00	
	150/15	15mm	Clip in label for item 161/MT	500 pieces	52.00	
	150/20	20mm	Clip in label for item 161/MT	200 pieces	48.00	
	150/25*	25mm	Clip in label for item 161/MT	200 pieces	48.00	
	150/30	30mm	Clip in label for item 161/MT	200 pieces	40.00	
	<b>Clip-on for MCB</b>					
	152N140	14mm	ABB Miniature Circuit Breaker	200 pieces	39.00	
	152N170	17mm	ABB Miniature Circuit Breaker	200 pieces	39.00	
	<b>Horizontal Terminal Block Marker</b>					
	<b>PHOENIX</b>					
	155 E 060	6mm wide		1000 pieces	71.00	
	<b>WEIDMULLER</b>					
	155 L 050	5mm wide		1000 pieces	71.00	
	157 L 150	15mm wide		500 pieces	48.00	
	<b>SIEMENS</b>					
	157 G 150	15mm wide		500 pieces	48.00	
158 E 200	20mm wide	Phoenix C	200 pieces	22.00		
<b>Note: Other brands and widths available upon request.</b>						
<b>Adhesive Channel for Clip-in Label 150 series</b> 	161/MT	500mm Channel for use with 150 Clip-In labels		20 Bars	51.00	
	<b>Clip-on Terminal Block Markers</b>					
	175A/15	15mm	Cabur/Wago	200 pieces	39.00	
	175C/15	15mm	Entrelec	200 pieces	39.00	
	175D/15	15mm	Legrand	200 pieces	39.00	
	175E/15	15mm	Phoenix/Allen Bradley 1492-HM	200 pieces	39.00	
	175G/15	15mm	Siemens	200 pieces	39.00	
	175H/15	15mm	Woertz/Allen Bradley 1492-W	200 pieces	39.00	
	175L/15	15mm	Weidmuller Sak/WDU	200 pieces	39.00	
	175M/15	15mm	Wieland, Telemecanique, Sprecher & Schuh	200 pieces	39.00	
	<b>Note: Other brands available upon request. Refer to Terminal Block Diagram on Page 21</b>					
<b>Contactors and Relay Marker</b> 	185G/20	20mm	Siemens/Klockner Moeller	200 pieces	39.00	
	185M/20	20mm	Telemecanique	200 pieces	39.00	
	<b>Transparent Sleeve for Electronic Wires</b>					
	190/10	10mm		1000 pieces	27.00	
	190/15	15mm	Cable O.D. 0.6 - 1.2mm(.023" - .047")20-28 AWG	1000 pieces	33.00	
	190/MT	25m Roll		25 Metres	46.00	
<b>Snap-on Sleeves</b> 	301/10	10mm		1000 pieces	45.00	
	301/15	15mm	Cable O.D. 2 - 3.5mm (.78" - .13")14-18 AWG	1000 pieces	51.00	
	301/23	23mm	Cable O.D. 2 - 3.5mm	500 pieces	40.00	
	301/30	30mm		500 pieces	51.00	
	302/15**	15mm	Cable O.D. 2.8 - 5mm (.11" - .19")10-12 AWG	1000 pieces	75.00	
	302/23**	30mm	Cable O.D. 2.8 - 5mm	500 pieces	58.00	
	302/30**	30mm		500 pieces	75.00	
	303/15**	15mm	Cable O.D. 5 - 8mm (.19" - .31")6-8 AWG	500 pieces	46.00	
	303/30**	30mm		200 pieces	38.00	
	304/15	15mm	Cable O.D. 8 - 10mm (.31" - .39")2-4 AWG	500 pieces	56.00	
	304/30	30mm		200 pieces	46.00	

\*Available upon request

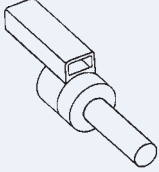
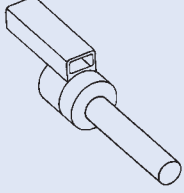
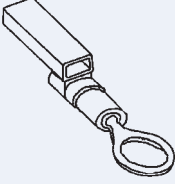
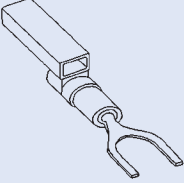
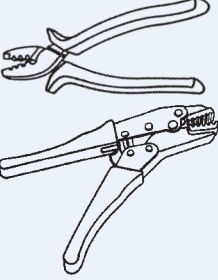
\*\*suitable for Cat5 wire

ITEM	CODE	DESCRIPTION				QTY	PRICE
<b>Spark Crimp-on Pins Standard/ Short Series</b> 	<b>Marking Recess 15mm Long</b>						
	710/05	9mm Pin	0.50mm <sup>2</sup>	22-26 AWG wire	Orange	200 pieces	33.00
	710/07	9mm Pin	0.75mm <sup>2</sup>	20 AWG wire	Neutral	200 pieces	38.00
	710/10	9mm Pin	1.0mm <sup>2</sup>	18 AWG wire	Yellow	200 pieces	40.00
	710/15	9mm Pin	1.5mm <sup>2</sup>	16 AWG wire	Red	200 pieces	42.00
	710/25	12mm Pin	2.5mm <sup>2</sup>	14 AWG wire	Blue	200 pieces	44.00
	710/40	12mm Pin	4.0mm <sup>2</sup>	12 AWG wire	Neutral	100 pieces	27.00
	710/60	12mm Pin	6.0mm <sup>2</sup>	10 AWG wire	Green	100 pieces	29.00
	710/100	12mm Pin	10.0mm <sup>2</sup>	8 AWG wire	Brown	100 pieces	32.00
<b>Spark Crimp-on Pins Standard/ Long Series</b> 	<b>Marking Recess 15mm Long</b>						
	711/05	14mm Pin	0.50mm <sup>2</sup>	22-26 AWG wire	Orange	200 pieces	44.00
	711/07	14mm Pin	0.75mm <sup>2</sup>	20 AWG wire	Neutral	200 pieces	46.00
	711/10	14mm Pin	1.0mm <sup>2</sup>	18 AWG wire	Yellow	200 pieces	49.00
	711/15	14mm Pin	1.5mm <sup>2</sup>	16 AWG wire	Red	200 pieces	51.00
	711/25	17mm Pin	2.5mm <sup>2</sup>	14 AWG wire	Blue	200 pieces	52.00
	711/40	17mm Pin	4.0mm <sup>2</sup>	12 AWG wire	Neutral	100 pieces	33.00
	711/60	17mm Pin	6.0mm <sup>2</sup>	10 AWG wire	Green	100 pieces	34.00
	711/100	17mm Pin	10.0mm <sup>2</sup>	8 AWG wire	Brown	100 pieces	39.00
<b>Spark Ring Terminals</b> 	<b>Marking Recess 23mm Long</b>						
	720/R3	#6	3mm Stud size	18-20 AWG	Red	200 pieces	46.00
	720/R4	#8	4mm Stud size	18-20 AWG	Red	200 pieces	46.00
	720/R5	#10	5mm Stud size	18-20 AWG	Red	100 pieces	24.00
	720/R6	# 1/4	6mm Stud size	18-20 AWG	Red	100 pieces	29.00
	720/B3	#6	3mm Stud size	14-16 AWG	Blue	200 pieces	46.00
	720/B4	#8	4mm Stud size	14-16 AWG	Blue	200 pieces	46.00
	720/B5	#10	5mm Stud size	14-16 AWG	Blue	100 pieces	24.00
	720/B8	# 5/16	8mm Stud size	14-16 AWG	Blue	100 pieces	29.00
	720/Y4	#8	4mm Stud size	10-12 AWG	Yellow	100 pieces	33.00
	720/Y5	#10	5mm Stud size	10-12 AWG	Yellow	100 pieces	33.00
720/Y6	# 1/4	6mm Stud size	10-12 AWG	Yellow	100 pieces	39.00	
<b>Spark Spade Terminals</b> 	<b>Marking Recess 23mm Long</b>						
	730/R3	#6	3mm Stud size	18-22 AWG	Red	200 pieces	47.00
	730/R5	#10	5mm Stud size	18-22 AWG	Red	100 pieces	27.00
	730/B3	#6	3mm Stud size	14-16 AWG	Blue	200 pieces	47.00
	730/B4	#8	4mm Stud size	14-16 AWG	Blue	200 pieces	47.00
	730/B5	#10	5mm Stud size	14-16 AWG	Blue	100 pieces	27.00
	730/B6	# 1/4	6mm Stud size	14-16 AWG	Blue	100 pieces	27.00
	730/Y4	#8	4mm Stud size	10-12 AWG	Yellow	100 pieces	34.00
	730/Y5	#10	5mm Stud size	10-12 AWG	Yellow	100 pieces	34.00
730/Y6	# 1/4	6mm Stud size	10-12 AWG	Yellow	100 pieces	36.00	
<b>Spark Crimp Tool</b> 	770	Manual crimper for spark pins for 0.5 - 16mm <sup>2</sup>			8-20 AWG	1 piece	168.00
	790	Ratchet crimper for spark rings & spades				1 piece	336.00
<b>Spark Wire Stripper</b> 	780	Stripping and cutting wire up to 4mm <sup>2</sup>			10-28 AWG	1 piece	71.00

PRICES CONTINUED OVERLEAF

ITEM	CODE	DESCRIPTION	QTY	PRICE	
<b>Dual Recess Transparent Sleeve</b>  	802/15	15mm	500 pieces	42.00	
	802/30*	30mm	200 pieces	34.00	
	802/MT*	25M Roll	1 Piece	136.00	
	808/15	15mm	100 pieces	9.00	
	808/30	30mm	Cable O.D. 8 - 10mm (.31" - .39")	50 pieces	9.00
	808/MT*	500mm bars	40 bars	118.00	
	809/15	15mm	100 pieces	11.00	
	809/30	30mm	Cable O.D.10 - 12mm (.39" - .47")	50 pieces	11.00
	809/MT*	500mm bars	40 bars	132.00	
	810/15	15mm	100 pieces	11.00	
	810/30	30mm	Cable O.D. 12 - 14mm (.47" - .55")	50 pieces	11.00
	810/MT*	500mm bars	40 bars	132.00	
	811/15	15mm	50 pieces	9.00	
	811/30	30mm	Cable O.D. 14 - 16mm (.55" - .62")	20 pieces	8.00
811/MT*	500mm bars	40 bars	161.00		
<b>Dual Recess Cable Tie Sleeve</b>  	830/30	30mm	Use with up to 6mm wide cable ties	200 pieces	33.00
<b>Dual Recess Adhesive Label</b>  	840/15	15mm	Dual recess adhesive label	200 pieces	38.00
	840/30	30mm	Dual recess adhesive label	100 pieces	38.00
	840/MT*	500mm	Dual recess adhesive bars	20 bars	105.00
<b>Halogen Free Transparent Sleeves</b>  	901HF/15	15mm		1000 pieces	56.00
	901HF/23*	23mm	Cable O.D. 0.9 - 1.6mm (.035" - .063")	500 pieces	40.00
	901 HF/30	30mm		500 pieces	56.00
	902HF/15	15mm		1000 pieces	70.00
	902HF/23*	23mm	Cable O.D. 1.4 - 5mm (.055" - .20")	500 pieces	49.00
	902HF/30	30mm		500 pieces	70.00
	903HF/15	15mm		500 pieces	44.00
	903HF/23*	23mm	Cable O.D. 5 - 11mm (.20" - .43")	200 pieces	24.00
903HF/30	30mm		200 pieces	34.00	
<b>Halogen Free Sleeve for Cable Tie</b>  	930HF/30	30mm	Use with up to 6mm wide cable ties (1/4")	200 pieces	39.00
<b>Large Cable Tie Sleeve Use with SIHF44 Tags</b>  	SI 1001	20mm	PVC - use with up to 6mm wide cable ties	240 pieces	32.00
	SI HFC1	20mm	Halogen Free - use with up to 6mm wide cable ties	240 pieces	38.00

\*Available upon request

# COMPUTER GENERATED MARKING



CHOOSE YOUR MARKING SOLUTION



## IN HOUSE MARKING SERVICE

Send us your list of numbers and we'll deliver back to you within 72 hours.



## DIY WITH SI2K THERMAL

Purchase our revolutionary SI2K Thermal Printer for fast 'DO IT YOURSELF' marking.



## DIY WITH SI2000 PLOTTER

Purchase our SI2000 Plotter for easy 'DO IT YOURSELF' halogen free marking.

FOR ALL OF YOUR WIREMARKING NEEDS



READ ON TO EXPLORE YOUR OPTIONS

# IN HOUSE MARKING SERVICE

## SEND US YOUR NUMBERS

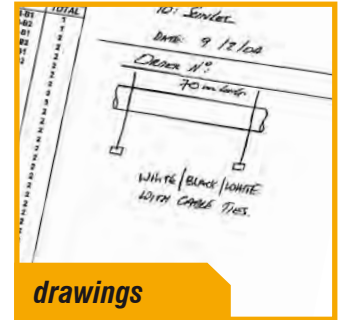
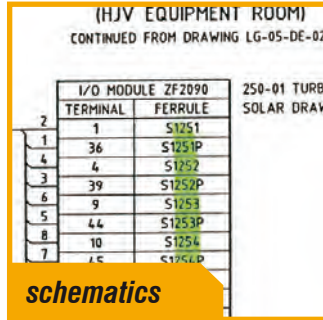
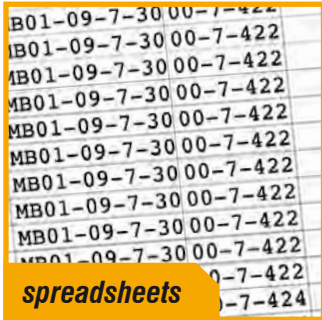

## WE'LL DO THE WORK



## AND DELIVER TO YOU

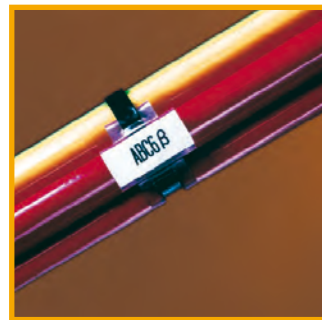

We can do the work for you. Once you have planned the job, simply provide us with your list of numbers for plotting. The quickest and easiest way to send this to us is via email on our spreadsheet format. There is no risk of error and turn around time is fast—even on large orders.

- 72 hour turnaround
- Free delivery
- Halogen free tags are available upon request
- Via electronic source, hand drawn lists, schematics or spreadsheets
- Avoid double entry. Convert your AUTOCAD, EPLAN files (or similar) - just ask how
- Minimum order quantities

*For more information on our plotted tag service or for a copy of our spreadsheet format call 1800 864 3874.*



# IN HOUSE MARKING SERVICE

## WIRE MARKERS (available in white or yellow)

SIHF (Halogen Free)	10mm, 15mm, 23mm, 30mm, 40mm	POA
SI2K02N (Halogen Free)	10mm, 15mm, 18mm	POA
SI2K02 (Halogen Free)	30mm	POA



## TERMINAL MARKERS

SIHF (Halogen Free) Series*	POA
SI2KTB Series*	POA

\*To suit most brands ie; Entrelec, Telemecanique, S & S, Legrand, Wago, Allen Bradley, Wieland, Cabur, Weidmuller, WDU-SAK, Siemens, Phoenix, Wago 280, Automation Direct, Entrelec  
 \*\*Other brands available upon request.

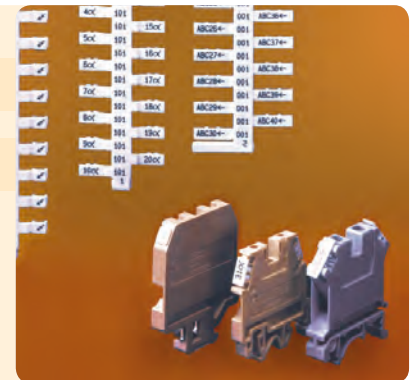

## CONTACTORS

SIHF (Halogen Free) Series*	POA
-----------------------------	-----

\*To suit most brands ie; Klockner Moeller, Telemecanique, Siemens Sirius-3R, Allen Bradley etc.  
 \*\*Other brands available upon request.



## CABLE MARKERS (available in white or yellow)

SIHF Series (Halogen Free)	20mm	POA
SI2K Series (Complete with sleeve)	35mm, 70mm, 105mm	POA



## SELF ADHESIVE (available in white or yellow)

SIHF42 Series (Halogen Free)	20mm	POA
SI2K Series	20mm	POA
SIT804 Series	Size upon request	POA

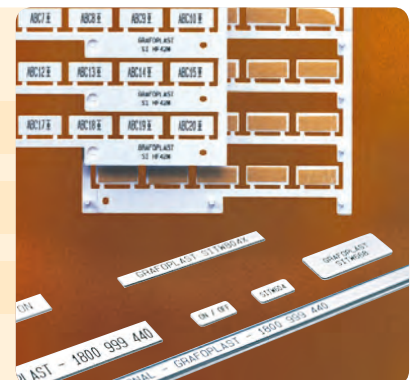

**D.I.Y.** DO IT YOURSELF



## **Purchase the new compact SI2K Thermal Printer!**





The SI2K thermal transfer printer is the most enhanced and versatile system for the marking of all electrical components.

A thermal transfer marking technique, that uses ribbons with special ink, ensures the quality and life of the marking on many plastic materials such as; PVC, Polyester, ABS, Polycarbonate.

Data preparation with the Simplo 2000 Software is quick and easy. Save time and convert your Autocad, Eplan files (or similar). With total flexibility you can print wire and cable numbers, plates & labels for control panels, outside panels and adhesive strips, all tailored to your individual requirements and specifications. Printing is noiseless and fast.

**COMPLETELY  
COMPATIBLE**

**TRASP  
SYSTEM**

-  5500 tags per hour (approx)
-  High quality resolution print
-  Low maintenance
-  Compact design and portable
-  Backup support eliminates downtime

**For pricing & more information on this  
revolutionary wiremarking system CALL 1800 864 3874**



**AUTOMATIC FEED**

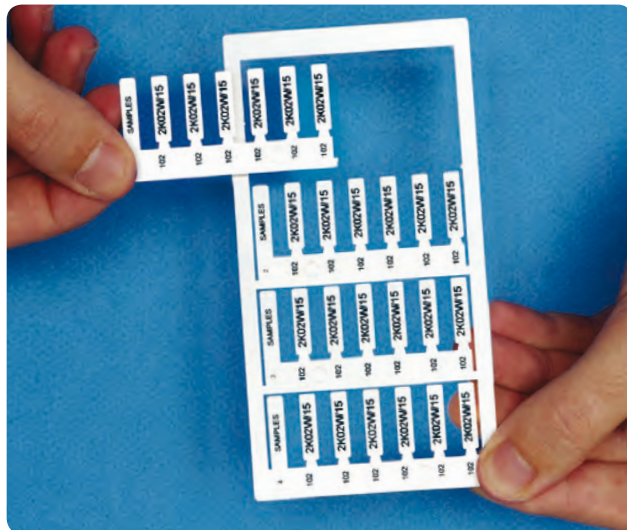

**SEMI-AUTOMATIC FEED**

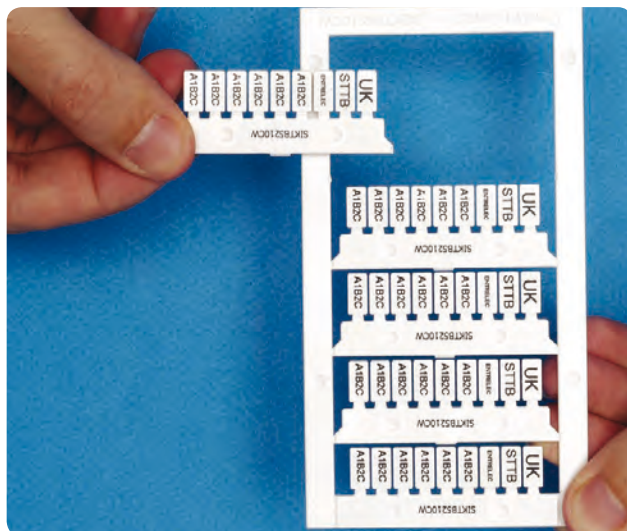

**MANUAL FEED**



APPLICATIONS

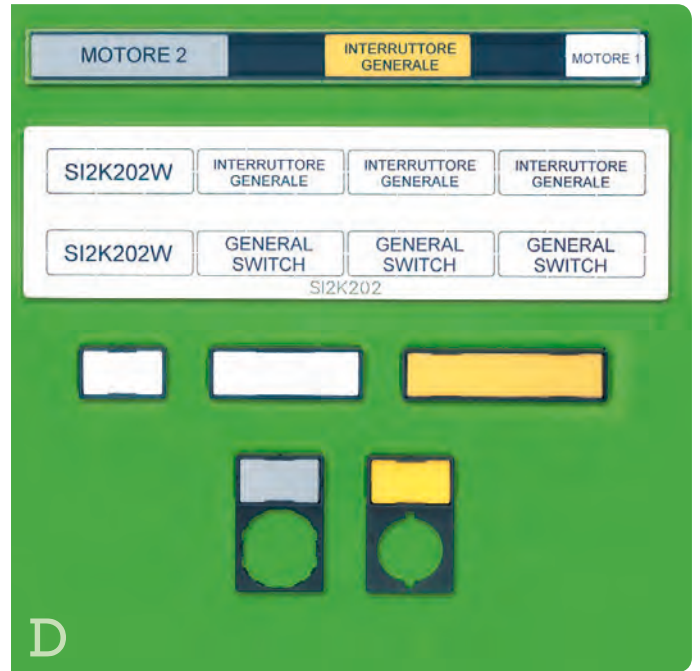
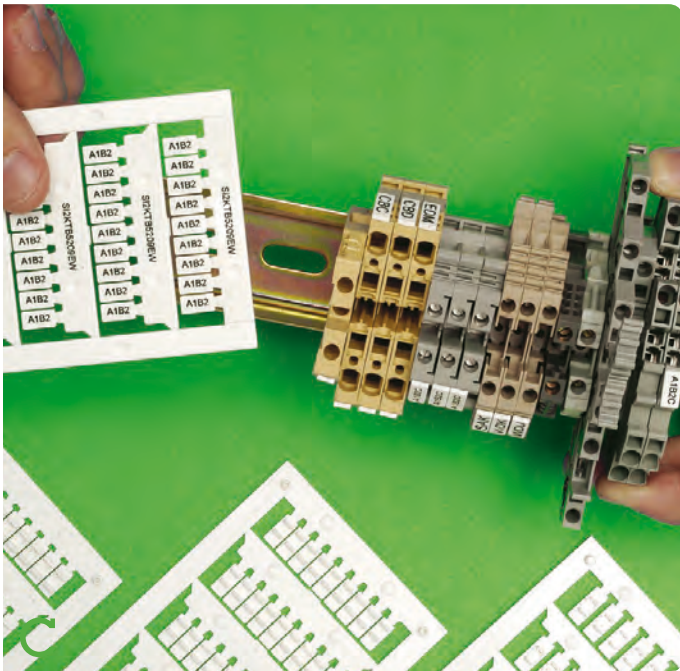
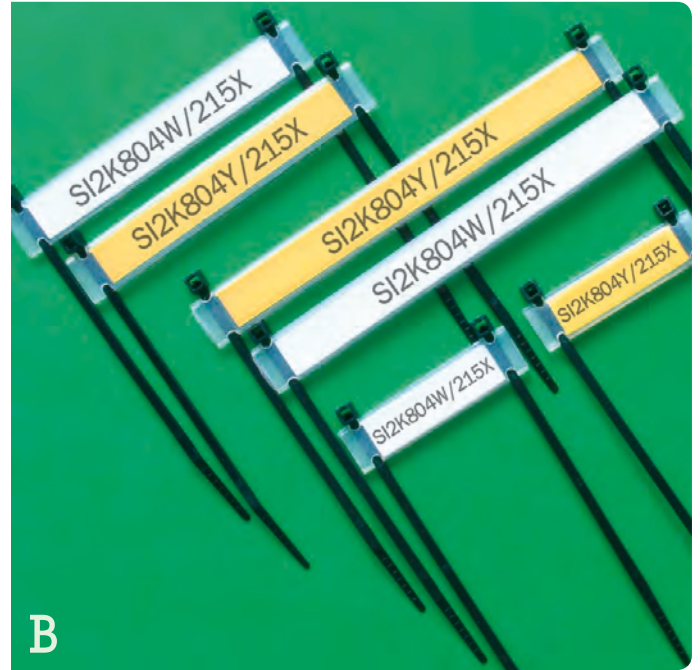
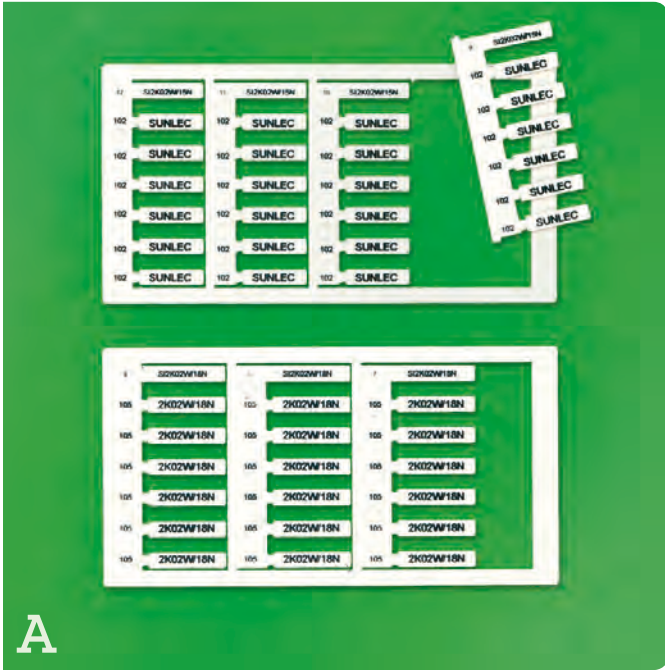

APPLICATIONS

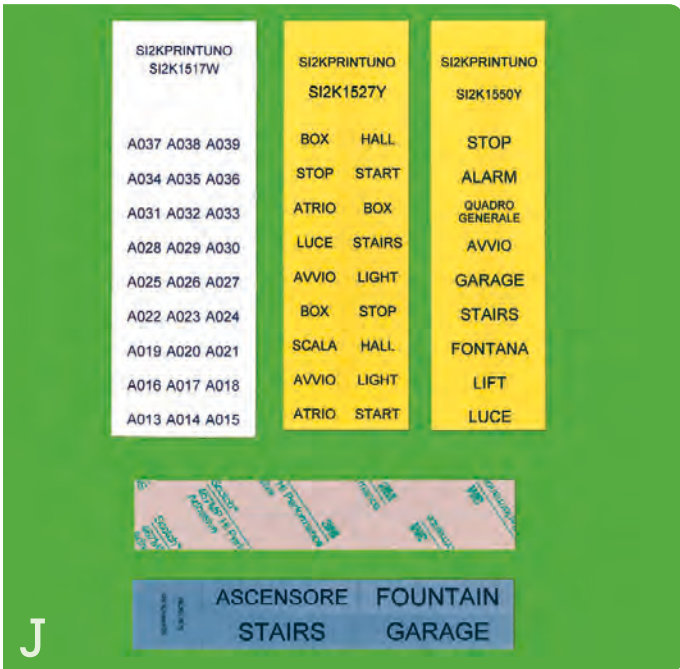



# SI2000 PLOTTER SYSTEM

COMPUTER GENERATED WIRE MARKERS





# D.I.Y.

## DO IT YOURSELF



***Purchase our unique computer driven marking system!***

Perfect for every kind of cable, label and terminal block with great speed and accuracy. Our tags assure you high resistance against aging, oil and abrasions. Best of all, our plotting system is totally compatible with the TRASP system, meaning that you can use the plotted tags in conjunction with the TRASP system without any costly adjustments. Our Grafoplast S12000 plotter system software can be used with your own personal computer.

-  Maintain control and minimise any delays - produce your wiremarking in-house or on-site
-  No fading or leeching, not affected by oils, grease or abrasives
-  Backup support eliminates any downtime
-  Halogen Free products available

***For pricing & more information***

***CALL 1800 864 3874***

# APPLICATIONS



# DIAMETER - CABLE SECTIONS CROSS REFERENCE

FOR CABLE SIZE mm<sup>2</sup>

CODE	OD	0.14	0.25	0.50	0.75	1.00	1.50	2.50	4	6	10	16	25	35	50	70	95	120	150	185	240	300	400	500
101	1÷2	■	■	■	■	■																		
102	2÷3		■	■	■	■	■																	
103	3÷4			■	■	■	■	■																
104	4÷5						■	■	■															
105	5÷6							■	■	■														
106	6÷7								■	■	■													
107	7÷8							■	■	■	■													
108	8÷10							■	■	■	■	■												
109	10÷12						■	■	■	■	■	■	■											
110	12÷14							■	■	■	■	■	■	■										
111	14÷26										■	■	■	■	■	■								
112	16÷18											■	■	■	■	■								
113	18÷20												■	■	■	■	■	■						
114	20÷22													■	■	■	■							
115	22÷25														■	■	■	■	■	■				
116	25÷30																■	■	■	■	■	■		
190	0.6÷1.2	■	■																					
201	1.5÷2.5		■	■	■	■	■																	
202	2÷4			■	■	■	■	■																
203	4÷7						■	■	■	■														
204	6÷10							■	■	■	■	■												
205	10÷14								■	■	■	■	■											
206	14÷22										■	■	■	■	■	■	■	■						
207	22÷30															■	■	■	■	■	■	■		
208	30÷35																		■	■	■	■	■	■
209	35÷40																				■	■	■	■
301	2÷3.5		■	■	■	■	■	■																
302	2.8÷5			■	■	■	■	■	■															
303	5÷8						■	■	■	■														
304	8÷10							■	■	■	■	■												
401	1.5÷2.5		■	■	■	■	■																	
402	2÷4			■	■	■	■	■																
403	4÷7						■	■	■	■														
404	6÷10							■	■	■	■	■												
405	10÷14								■	■	■	■	■											
406	14÷22										■	■	■	■	■	■	■							
802	2÷4		■	■	■	■	■																	
808	8÷10						■	■	■	■	■	■	■											
809	10÷12						■	■	■	■	■	■	■	■										
810	12÷14							■	■	■	■	■	■	■	■									
811	14÷16										■	■	■	■	■	■								
901	0.9÷1.6	■	■																					
902	1.4÷5		■	■	■	■	■	■																
903	5÷11									■	■	■	■											

**NOTE:** All the above data has an approximate value and refers exclusively to the diameters of single-cores. The appreciable differences in outside diameters of similar cable sections, are the result of differences in the thickness of the insulation of the cables. When choosing a sleeve according to cable section, please also refer to specific cable manufacturers data.

# TERMINAL BLOCK DIAGRAM

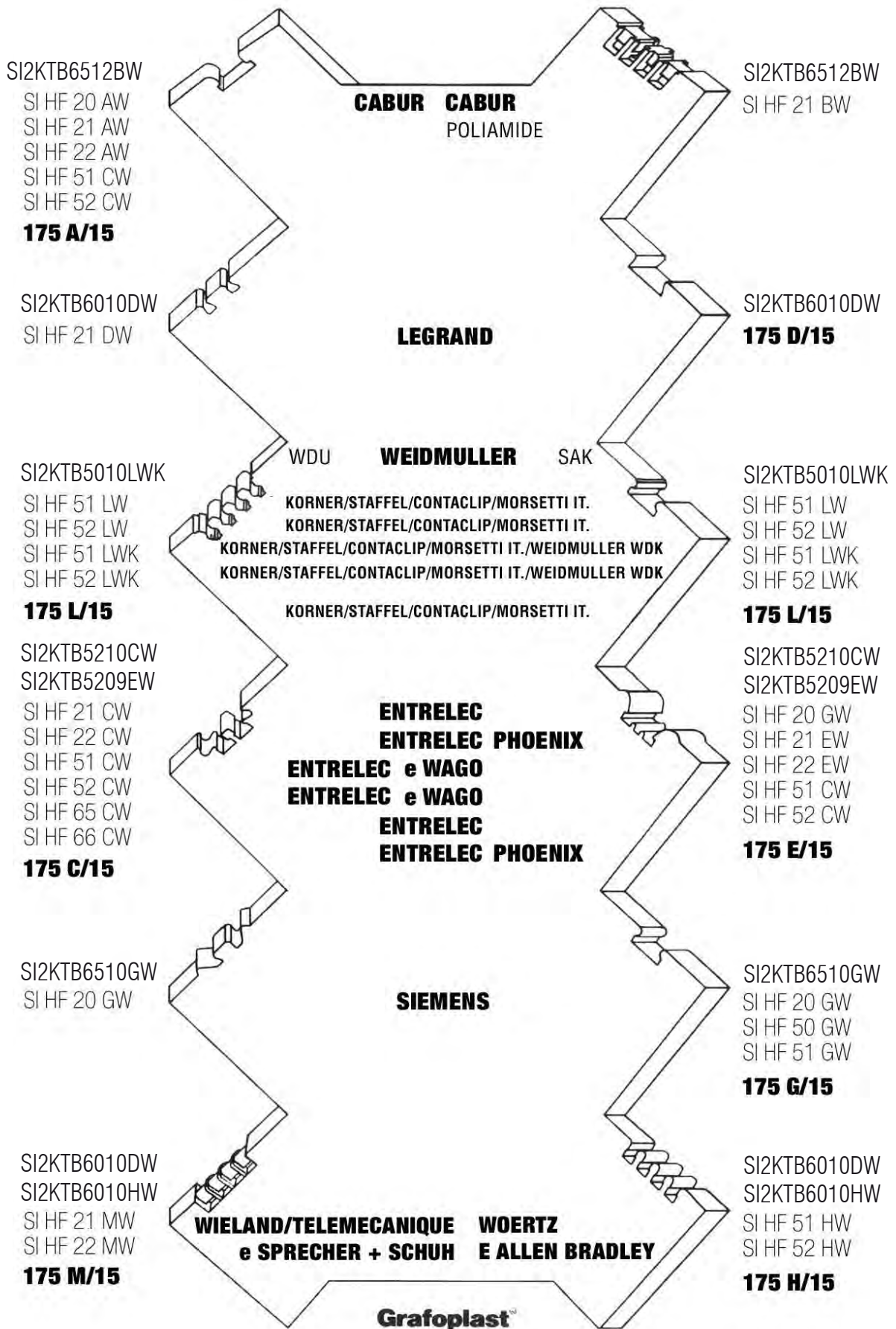

# METRIC TO US CONVERSION

(ONLY TO BE USED IN CONJUNCTION WITH THIS CATALOG)

mm	metres	inches	feet
0.5	-	0.019	-
0.75	-	0.029	-
1	-	0.039	-
1.5	-	0.059	-
2	-	0.078	-
2.5	-	0.098	-
3	-	0.12	-
4	-	0.16	-
5	-	0.20	-
6	-	0.24	-
7	-	0.27	-
8	-	0.31	-
9	-	0.35	-
10	-	0.39	-
12	-	0.47	-
14	-	0.55	-
15	-	0.59	-
16	-	0.63	-
17	-	0.67	-
18	-	0.71	-
20	-	0.79	-
22	-	0.87	-
25	-	0.98	-
30	-	1.18	-
170	-	6.69	-
205	-	8.07	-
220	-	8.66	-
400	-	15.75	-
500	-	19.69	-
-	10	-	33
-	20	-	65
-	25	-	82



# TECHNICAL PAGE

## CROSS REFERENCE CHART FOR SLEEVE SELECTION

Rubber-covered and Thermoplastic-covered wires and cables.  
Information on U.S. wires has been obtained from the National Electric Code.  
Thickness of wire insulation varies by manufacturer and wire type.

size AWG MCM	Types of Wire RFH-2, RH, RHH***			Types of Wire TF, THW*, TW			Types of Wire TFN, THHN, THWN		
	(O.D.) Outside Diameter		Grafoplast Sleeve size	(O.D.) Outside Diameter		Grafoplast Sleeve size	(O.D.) Outside Diameter		Grafoplast Sleeve size
	in.	mm		in.	mm		in.	mm	
18	.146	3.71	103	.106	2.69	102	.089	2.26	101
16	.158	4.01	104	.118	3.00	102	.100	2.54	102
14	.171	4.34	104	.131	3.33	103	.105	2.67	102
14	.204*	5.18	105	-	-	-	-	-	-
14	-	-	-	.162*	4.11	104	-	-	-
12	.188	4.78	104	.148	3.76	103	.122	3.10	103
12	.221*	5.61	105	-	-	-	-	-	-
12	-	-	-	.179*	4.55	104	-	-	-
10	.242	6.15	106	.168	4.27	104	.153	3.89	103
10	-	-	-	.199*	5.05	105	-	-	-
8	.328	8.33	108	.245	6.22	106	.218	5.54	105
8	-	-	-	.276*	7.01	107	-	-	-
6	.397	10.08	109	.323	8.20	108	.257	6.53	106
4	.452	11.48	109	.372	9.45	108	.328	8.33	108
3	.481	12.22	110	.401	10.19	109	.356	9.04	108
2	.513	13.03	110	.433	11.00	109	.388	9.86	108
1	.588	14.94	111	.508	12.90	110	.450	11.43	109
1/0	.629	15.98	111	.549	13.94	110	.491	12.47	110
2/0	.675	17.14	112	.595	15.11	111	.537	13.64	110
3/0	.727	18.67	113	.647	16.43	112	.588	14.94	111
4/0	.785	19.94	113	.705	17.91	112	.646	16.41	112
250	.868	22.05	115	.788	20.02	114	.716	18.19	113
300	.933	23.70	115	.843	21.41	114	.771	19.58	113
350	.985	25.02	116	.895	22.83	115	.822	20.88	114
400	1.032	26.21	116	.942	23.93	115	.869	22.07	115
500	1.119	28.42	116	1.029	26.14	116	.955	24.26	115
600	1.233	31.32	208	1.143	29.03	116	1.038	26.87	116
700	1.304	33.12	208	1.214	30.84	208	1.129	28.68	116
750	1.339	34.01	208	1.249	31.72	208	1.163	29.54	116
800	1.372	34.85	209	1.282	32.56	208	1.196	30.38	208
900	1.435	36.45	209	1.345	34.16	208	1.259	31.98	208
1000	1.494	37.95	209	1.404	35.66	209	1.317	33.45	208
1250	1.676	42.57	130/30	1.577	40.66	130	-	-	-
1500	1.801	45.74	130/30	1.702	43.23	130/30	-	-	-
1750	1.916	48.67	130/30	1.817	46.15	130/30	-	-	-
2000	2.021	51.33	130/30	1.922	48.82	130/30	-	-	-

\*The dimensions of types RHH and RHW

\*\*Dimensions of THW in sizes No. 14 through No. 8. No. 6 THW and larger is the same dimension as TW.

\*\*\* Dimensions of RHH and RHW without outer covering are the same as THW No. 18 through No. 10, Solid; No. 8 and larger stranded.

# TECHNICAL PAGE

## CROSS REFERENCE CHART FOR SLEEVE SELECTION

Rubber-covered and Thermoplastic-covered wires and cables.  
 Information on U.S. wires has been obtained from the National Electric Code.  
 Thickness of wire insulation varies by manufacturer and wire type.

size AWG MCM	Types of Wire XHHW, ZW**			Types of Wire**** FEP, FEPB, FEPW, TFE, PF, PFA, PFAH, PGF, PTF, Z, ZF, ZFF			Types of Wire KF-1, KF-2, KFF-1, KFF-2		
	(O.D.) Outside Diameter		Grafoplast Sleeve	(O.D.) Outside Diameter		Grafoplast Sleeve	(O.D.) Outside Diameter		Grafoplast Sleeve
	in.	mm	size	in.	mm	size	in.	mm	size
18	-	-	-	.081	2.06	102	.065	1.65	101
16	-	-	-	.092	2.34	102	.070	1.78	101
14	.129	3.28	103	.105	2.67	102	.083	2.11	102
12	.146	3.71	103	.121	3.07	103	.102	2.59	102
10	.166	4.22	104	.142	3.61	103	.124	3.15	103
8	.241	6.12	106	.206	5.23	105	-	-	-
				(.186)	(4.72)	104			
6	.282	7.16	107	.244	6.20	106			
				(.302)	(7.67)	107			
4	.328	8.33	108	.292	7.42	107			
				(.350)	(8.89)	108			
3	.356	9.04	108	.320	8.13	108			
				(.378)	(9.60)	108			
2	.388	9.86	108	.352	8.94	108			
				(.410)	(10.41)	109			
1	.450	11.43	109	.420	10.67	109			
1/0	.491	12.47	110	.462	11.73	109			
2/0	.537	13.64	110	.498	12.65	110			
3/0	.588	14.94	111	.560	14.22	111			
4/0	.646	16.41	112	.618	15.70	111			
250	.716	18.19	113						
300	.771	19.58	113						
350	.822	20.88	114						
400	.869	22.07	115						
500	.955	24.26	115						
600	1.073	27.25	116						
700	1.145	29.08	116						
750	1.180	29.97	116						
800	1.210	30.73	208						
900	1.270	32.26	208						
1000	1.330	33.78	208						
1250	1.500	38.10	209						
1500	1.620	41.15	130/30						
1750	1.740	44.20	130/30						
2000	1.840	46.73	130/30						

\*\*\*\* The values shown for sizes No. 1 through 4/0 are for TFE and Z only.

( ) The Values in parenthesis are for FEPB, Z, ZF and ZFF only.

\*\* No. 14 through No. 2.

# Grafoplast at Work





**Grafoplast<sup>®</sup>**  
**Wiremakers Inc.**

Phone: 1-303-321-5995

Fax: 1-303-399-5054

Toll Free: 1-800-864-3874

[www.grafoplast.com](http://www.grafoplast.com)