

1 Introduction

This document provides operating, maintenance and installation instructions. This unit measures and displays the characteristics of Single Phase Two Wire (1P2W) and 2 x (C1 & C2) Three Phase Four Wire (3P4W) networks. The measuring parameters include Voltage (V), Current (A), Frequency (Hz), Power (kW/KVA/KVAh), Power Factor (PF), Imported, Exported and Total Energy (kWh/kVAh). The unit also measures Maximum Demand Current and Power, this is measured over preset periods of up to 60 minutes.

This particular model accommodates 100mA Current Transformers and can be configured to work with a wide range of CTs. It also comes with a complete comms capability with built in RS485 Modbus RTU outputs, configuration is password protected.

This unit can be powered from a separate auxiliary supply (AC or DC). Alternatively, it can be powered from the monitored supply by linking the voltage reference and neutral reference in to terminals 5 & 6 (Please refer to wiring diagram).

1.1 Unit Characteristics

The SDM630MCT-2L can measure and display 2 x Three Phase circuits (C1 & C2):

- Phase to Neutral Voltage and THD% (Total Harmonic Distortion) of all Phases
- Line Frequency
- Current, Maximum Demand Current and Current THD% of all Phases
- Power, Maximum Power Demand and Power Factor
- Imported, Exported & Total Active Energy
- Imported, Exported & Total Reactive Energy

The unit has a Password-Protected set up menu for:

- Changing the Password
- System Configuration - 1P2W & 3P4W.
- Demand Interval Time
- Reset for Demand Measurements



1.2 Current Transformer Primary Current

This unit requires configuring to operate with the appropriate current transformer(s), the secondary current is 0.1A. It is programmed by inputting the ratio (CT Primary). It can be used on primary currents up to 6000A.

1.3 RS485 Serial – Modbus RTU

This unit is compatible with remote monitoring through RS485 Modbus RTU. Set-up screens are provided for configuring the RS485 port. Refers to section 4.8.

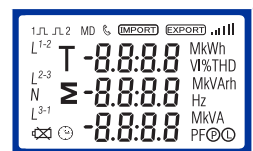



2 Start Up Screens

	The first screen lights up all display segments and can be used as a display check.
	The second screen indicates the firmware installed in the unit and its build number.
	The interface performs a self-test and indicates the result if the test passes.



*After a short delay, the screen will display active energy measurements.

3 Measurements

The buttons operate as follows:





	Selects the Voltage and Current display screens. In Set-up Mode, this is the "Left" (press) or "Escape" (hold 3sec) button.
	Select the Frequency and Power factor display screens. In Set-up Mode, this is the "Up" (press) button.
	Select the Power display screens. In Set-up Mode, this is the "Down" (press) button.
	Select the Energy display screens. In Set-up mode, this is the "Right" (press) or "Enter" (hold 3sec) button.

3.1 Switching Three Phase Circuit Display

	Default is Circuit 1 (C1).
	To Switch from Circuit 1 (C1) to Circuit 2 (C2) press and hold the P button. Press and hold again to switch back to C1.



3.1.1 Voltage and Current

Each successive press of the U/ESC button selects a new parameter:

	Phase to neutral voltages.
	Phase to Phase voltages.
	Current on each phase.
	Phase to neutral voltage THD%.
	Current THD% for each phase.



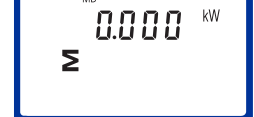

3.2 Frequency and Power Factor and Demand

Each successive press of the M button selects a new range:

	Frequency and Power Factor (total).
	Power Factor of each phase.
	Maximum Power Demand.
	Maximum Current Demand.

3.3 Power





Each successive press of the P button select a new range:

	Instantaneous Active Power in kW.
	Instantaneous Reactive Power in kVAh.
	Instantaneous Volt-Amps in KVA.
	Total kW, kVAh, KVA.

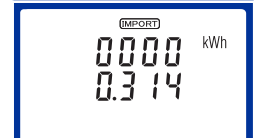
3.4 Energy Measurements

Each successive press of the E button selects a new range:

	Imported active energy in kWh.
	Exported active energy in kWh.

	Imported reactive energy in kVAh.
	Exported reactive energy in kVAh.
	Total active energy in kWh.
	Total reactive energy in kVAh.

Please note the register is 9999999.9 display over two lines.

4 Set Up

4.1 Set up Entry Methods

Some menu items, such as Password and CT, require a four-digit number entry while others, such as supply system, require selection from a number of menu options.

4.1.1 Menu Option Selection

1. Use the M and P buttons to scroll through the different options of the set up menu.
2. Hold the E button for 3 seconds to confirm your selection.
3. If an item flashes, then it can be adjusted by the M and P buttons.
4. Having selected an option from the current layer, hold the E button for 3 seconds to confirm your selection.
5. Having completed a parameter setting, hold the U/ESC button for 3 seconds to return to a higher menu level.
6. On completion of all setting-up, hold the U/ESC button for 3 seconds, the measurement screen will then be restored.

4.1.2 Number Entry Procedure



When setting up the unit, some screens require the entering of a number. In particular, on entry to the setting up section, a password must be entered. Digits are set individually, from left to right. The procedure is as follows:

1. The current digit to be set flashes and then can be adjusted using the M and P buttons.
2. Press the E button to move right to the next digit.
3. After setting the last digit, hold the E button for 3 seconds to save your selection.

4.2 Communication



The RS485 port can be used for communication using Modbus RTU Protocol. To configure the Modbus settings, such as Address and Baud Rate, this is also done within the Password-protected set up menu.

4.2.1 RS485 Address

	Use the M and P buttons to select the menu option. The screen will show the current setting.
	Hold the E button to set the meter Address. Range: 001(default) to 247.
	Hold the E button to confirm the selection.



Use the M and P buttons to choose the necessary number, then press the E button to move along to the next number. To save the new setting, hold the E button for 3 seconds until the selection stops flashing.

4.2.2 Baud Rate

	Use the M and P buttons to select the menu option. The screen will show the current setting.
	Hold the E button to enter the menu option, the current selection will flash.
	Use the M and P buttons to select the required option.



On completion of the entry procedure, hold the E button to confirm the setting.

4.2.3 Parity

	Use the M and P buttons to select the menu option. The screen will show the current setting.
	Hold the E button to enter the menu option, the current selection will flash.
	Use the M and P buttons to select the required option. Range: None (default), Odd or Even.

On completion of the entry procedure, hold the E button for 3 seconds until the selection stops flashing.



4.2.4 Stop bits

	Use the M and P buttons to select the menu option. The screen will show the current setting.
	Hold the E button to enter the menu option, the current selection will flash.
	Use the M and P buttons to select the required option. Range: 1 (default) or 2.

On completion of the entry procedure, hold the E button for 3 seconds until the selection stops flashing.

4.5 CT Configuration

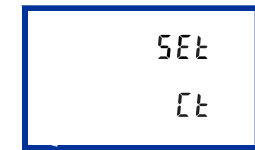

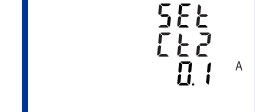
This unit is CT Operated, the primary (CT1) and secondary (CT2) of the current transformer need to be programmed correctly for the meter to scale the inputs accordingly.

	Use the M and P buttons to select the menu option. The screen will show the configure CT setting.
	Set the CT Ratio Value: Hold the E button to enter the CT Ratio setting screen. The range is from 0001 to 9999. 0005A default
	o Switch from Circuit 1 (C1) to Circuit 2 (C2) press and hold the P button. Press and hold again to switch back to C1.
	Secondary CT (CT2): Hold the E button to set the CT secondary option: 0.1A.(Not Configurable)

The CT Rate is the primary rate/ratio of the CT. For Example: 200/100mA Current Transformers, so the CT Rate would be 0200 and the CT2 would be 0.1A.

4.6 PT

The PT option sets the Secondary Voltage (PT2 100-500V) of the Voltage Transformer (PT) that may be connected to the meter.

	Use the M and P buttons to select the menu option. The screen will show the current setting. The default value is 400V.
	Secondary PT Setting: Hold the E button to set the PT secondary option: 100-500V.
	Set the PT Ratio Value: Hold the E button to enter the PT Ratio setting screen. The range is from 0001 to 9999.

The PT Rate is the PT Primary divided by the PT Secondary. For Example: Voltage Transformer - 11000÷110=100, so the PT Rate would be 0100 and the PT2 would be 110.

4.7 DIT (Demand Integration Time)

This sets the period (in minutes) in which the Current and Power readings are integrated for maximum demand measurement. The options are off; 5; 10; 15; 30 or 60 minutes.

	Use the M and P buttons to select the menu option. The screen will show the current setting.
	Hold the E button to enter the menu option, the current selection will flash.
	Use the M and P buttons to select the required option.
	Hold the E button to confirm the selection.

Hold the **U/I** button for 3 seconds to exit the set up menu.

4.8 Set backlight Display

The meter provides a function to set how long you want the display screen back light to be active

	Use the M and P buttons to select the menu option. The screen will show the current setting default 0 meaning it is on indefinitely. Option: 0, 5, 10, 30, 60 & 120.
--	--

Hold the **E** button to confirm the setting and press **U/I** to return to the main set up menu.

4.9 Supply System

The unit has a default setting of 3 Phase 4 Wire (3P4W). Use this section to set the type of electrical system.

	Use the M and P buttons to select the menu option. The screen will show the current setting.
	Hold the E button to enter the menu option, the current selection will flash.
	Use the M and P buttons to select the required option.

Hold the **E** button to confirm your adjustment. Hold the **U/I** button for 3 seconds to exit the set up menu.

4.10 CLR

The meter provides a function to reset the maximum demand value of current and power.

	Use the M and P buttons to select the menu option. The screen will show the current setting.
	Hold the E button to enter the menu option, the current selection will flash.

Hold the **E** button to confirm the setting and press **U/I** to return to the main set up menu.

4.11 Change Password

	Use the M and P to choose the change password option.
	Hold the E button to enter the set up menu. The first digit will start flashing.
	Use M and P to set the first digit and press E to move right. The next digit will flash.
	Repeat the procedure for the remaining three digits.
	After setting the last digit, Hold the E button to save your selection.

Hold the **U/I** button for 3 seconds to exit the set up menu.

4.12 P1 & P2 Reversal

If P1 is facing the load not the supply you need to reverse the flow direction through the "Set System Continued" menu:

	Use the M and P buttons to select the menu option. Hold the E button to view the sub-menu.
	This screen will display, you can change "Forward" to "Reverse" on each individual CT connection.
	Hold the E button to confirm your adjustment. You can then move on to IB or IC using the M and P buttons.

Hold the **U/I** button for 3 seconds to exit the set up menu

4.13 System Phase Sequence

The system sequence option sets the phase sequence with the voltage V1, V2 & V3 of the meter

	Use the M and P buttons to select the menu option. The screen will show the phase voltage sequence setting.
	Voltage Setting: Hold the E button to set the voltage option: V1, V2 & V3
	Set the Voltage for each phase: Hold the E button to enter the phase sequence screen. Option: CT1, CT2 & CT3.

5 Specifications

5.1 Measured Parameters

The unit can monitor and display the following parameters of a Single Phase Two Wire (1P2W) or Three Phase Four Wire (3P4W) system.

5.1.1 Voltage and Current

- Phase to Neutral Voltages 100-289V AC (not for 3P3W supplies).
- Phase to Phase Voltages 173-500V AC (3 Phase supplies only).
- Percentage Total Voltage Harmonic Distortion (V%THD) for each Phase to Neutral (not for 3P3W supplies).
- Percentage Total Voltage Harmonic Distortion (V% THD) between Phases (3 Phase supplies only).
- Current %THD for each Phase.

5.1.2 Power factor and Frequency and Max. Demand

- Frequency in Hz
- Instantaneous power:
- Power 0-3600 MW
- Reactive power 0-3600 MVAR
- Volt-amps 0-3600 MVA
- Maximum Demand Power since last reset
- Power factor
- Maximum Neutral Demand Current, since the last reset (for Three Phase supplies only)

5.1.3 Energy Measurements

- Imported/Exported active energy 0 to 9999999.9 kWh
- Imported/Exported reactive energy 0 to 9999999.9 kVARh
- Total active energy 0 to 9999999.9 kWh
- Total reactive energy 0 to 9999999.9 kVARh

5.2 Measured Inputs

Voltage inputs through 4-way fixed connector with 2.5mm² stranded wire capacity. Single Phase Two Wire (1P2W) OR Three Phase Four Wire (3P4W) unbalanced. Line frequency measured from L1 Voltage or L3 Voltage. Three current inputs (six physical terminals) with 2.5mm² stranded wire capacity for connection of external CTs. Nominal rated input current 0.1A AC RMS.

5.3 Accuracy

- Voltage 0.5% of range maximum
- Current 0.5% of nominal
- Frequency 0.2% of mid-frequency
- Power factor 1% of unity (0.01)
- Active power (W) ±1% of range maximum
- Reactive power (VAR) ±1% of range maximum
- Apparent power (VA) ±1% of range maximum
- Active energy (Wh) Class 1 IEC 62053-21
- Reactive energy (VARh) ±1% of range maximum
- Total harmonic distortion 1% up to 31st harmonic
- Response time to step input 1s, typical, to >99% of final reading, at 50 Hz.

5.4 Auxiliary Supply

This unit does not require a separate auxiliary supply; the unit is self supplied it draws the necessary power from the voltage input connections. If a three phase supply is connected, and the phase that is powering the unit fails, it will change the phase supply to avoid shutting down.

5.5 Interfaces for External Monitoring

Three interfaces are provided:

- RS485 communication channel that can be programmed for Modbus RTU protocol

The Modbus configuration (baud rate etc.) and the pulse relay output assignments (kW/kVARh) are configured through the set-up screens.

5.5.1 RS485 Output for Modbus RTU

For Modbus RTU, the following RS485 communication parameters can be configured from the set-up menu:

Baud rate: 2400, 4800, 9600, 19200, 38400

Parity: none (default) / odd / even

Stop bits: 1 or 2

RS485 Network Address: 3 digit number - 001-247

Modbus Word order Hi/Lo byte order is set automatically to normal or reverse. It cannot be configured from the set-up menu.

5.6 Reference Conditions of Influence Quantities

Influence Quantities are variables that affect measurement errors to a minor degree. Accuracy is verified under nominal value (within the specified tolerance) of these conditions.

- Ambient temperature 23°C ±1°C
- Input waveform 50 or 60Hz ±2%
- Input waveform Sinusoidal (distortion factor < 0.005)
- Auxiliary supply voltage Nominal ±1%
- Auxiliary supply frequency Nominal ±1%
- Auxiliary supply waveform (if AC) Sinusoidal (distortion factor < 0.05)
- Magnetic field of external origin Terrestrial flux

5.7 Environment

- Operating temperature -25°C to +55°C*
- Storage temperature -40°C to +70°C*
- Relative humidity 0 to 95%, non-condensing
- Altitude Up to 3000m
- Warm up time 1 minute
- Vibration 10Hz to 50Hz, IEC 60068-2-6, 2g
- Shock 30g in 3 planes

*Maximum operating and storage temperatures are in the context of typical daily and seasonal variation.

5.8 Mechanics

- DIN rail dimensions 72 x 94.5 mm (WxH) per DIN 43880
- Mounting DIN rail (DIN 43880)
- Sealing IP51 indoor
- Material Self-extinguishing UL 94 V-0

6 Dimensions

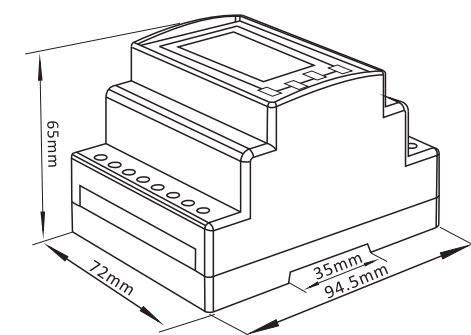

7 Installation

Wiring Three Phase Four Wire

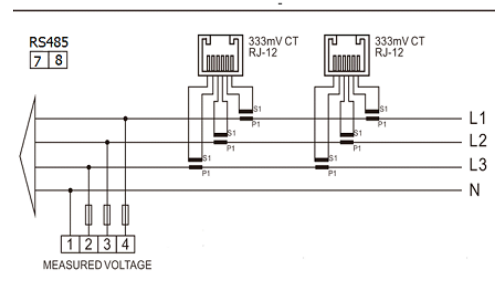

7.2 CT Orientation

With this meter the CT can be installed one of four ways depending in which way, will determine on the phase sequence of the meter

Option1 Default

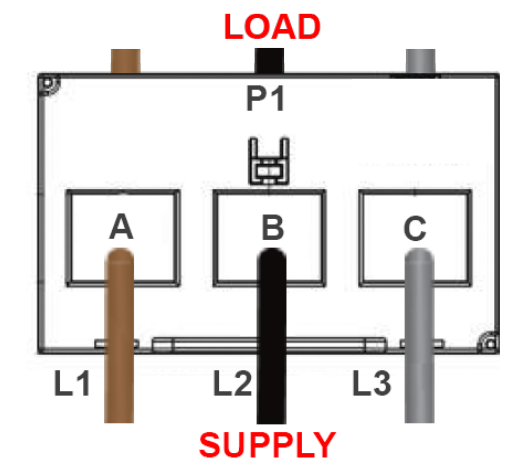

Option 2

Requires phase sequence, change L3 to L1 and L1 to L3, please refer to section 4.13

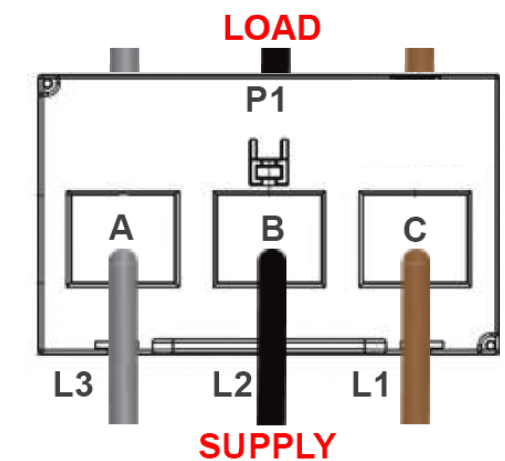

Option 3

Requires flow reversal, please refer to section 4.12

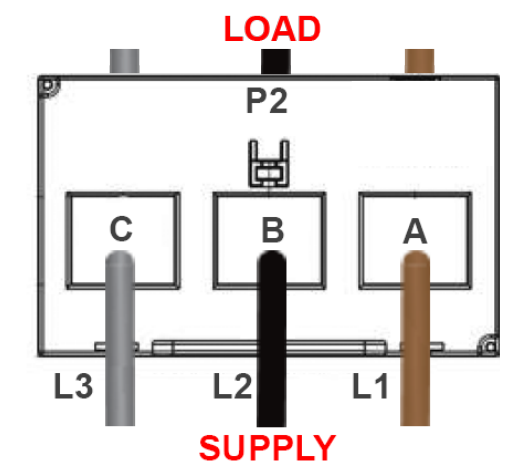

Option 4

Requires phase sequence change L3 to L1 and L1 to L3 please refer to section 4.13 and CT reversal, please refer to section 4.12

